



NTSC U/C

PlayStation™



SLUS-00398



Galaxian

Ms. Pac-Man

Pole Position II

Dig Dug

Phozon

The Tower of Druaga

N A M C O M U S E U M™

VOL. 3



WARNING: READ BEFORE USING YOUR PlayStation™ GAME CONSOLE.

A very small percentage of individuals may experience epileptic seizures when exposed to certain light patterns or flashing lights. Exposure to certain patterns or backgrounds on a television screen or while playing video games, including games played on the PlayStation game console, may induce an epileptic seizure in these individuals. Certain conditions may induce previously undetected epileptic symptoms even in persons who have no history of prior seizures or epilepsy. If you, or anyone in your family, has an epileptic condition, consult your physician prior to playing. If you experience any of the following symptoms while playing a video game – dizziness, altered vision, eye or muscle twitches, loss of awareness, disorientation, any involuntary movement, or convulsions – IMMEDIATELY discontinue use and consult your physician before resuming play.

WARNING TO OWNERS OF PROJECTION TELEVISIONS:

Do not connect your PlayStation game console to a projection TV without first consulting the user manual for your projection TV, unless it is of the LCD type. Otherwise, it may permanently damage your TV screen.

HANDLING YOUR PlayStation™ DISC:

- This compact disc is intended for use only with the PlayStation™ game console.
- Do not bend it, crush it or submerge it in liquids
- Do not leave it in direct sunlight or near a radiator or other source of heat.
- Be sure to take an occasional rest break during extended play.
- Keep this compact disc clean. Always hold the disc by the edges and keep it in its protective case when not in use. Clean the disc with a lint-free, soft, dry cloth, wiping in straight lines from center to outer edge. Never use solvents or abrasive cleaners.

TABLE OF CONTENTS

Greetings!	4
Getting Started	6
Basic Commands Inside the Museum	6
First Floor	8
Reception Area/Saving High Scores	8
Information	9
Record Book	10
Library	10
Theater	10
Second Floor	11
Main Hall	11
Game Room	12
Options Window	13
Galaxian	14
Ms. Pac-Man	16
Dig Dug	18
Pole Position II	19
Phozon	21
The Tower of Druaga	23

Set up your PlayStation™ game console according to the instructions in its Instruction Manual. Make sure the power is off before inserting or removing a compact disc. Insert the Namco Museum Volume 3 disc and close the CD door. Insert game controllers and turn on the PlayStation™ game console. Follow on-screen instructions to start a game.

Console

Top View

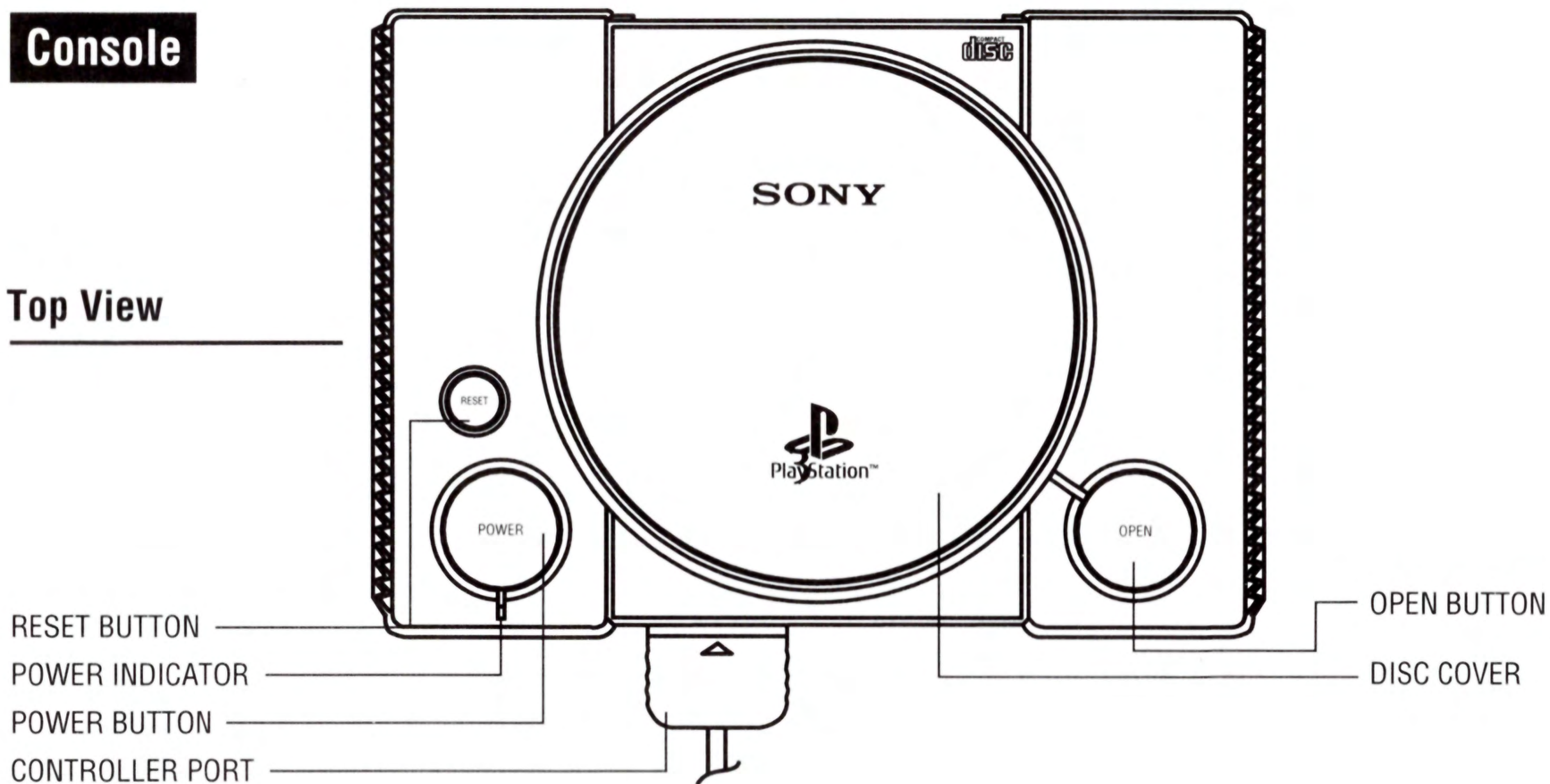

Front View

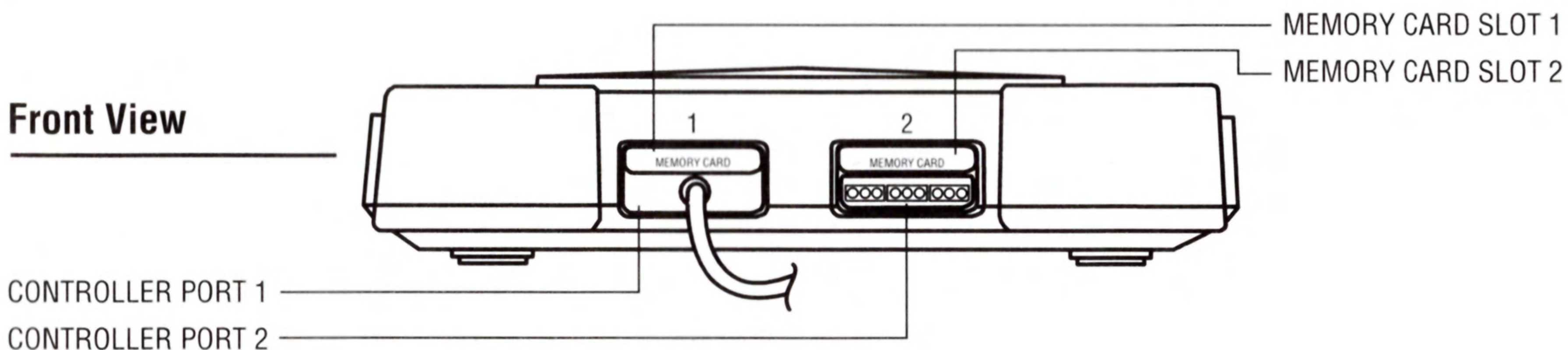

Controller

Front View

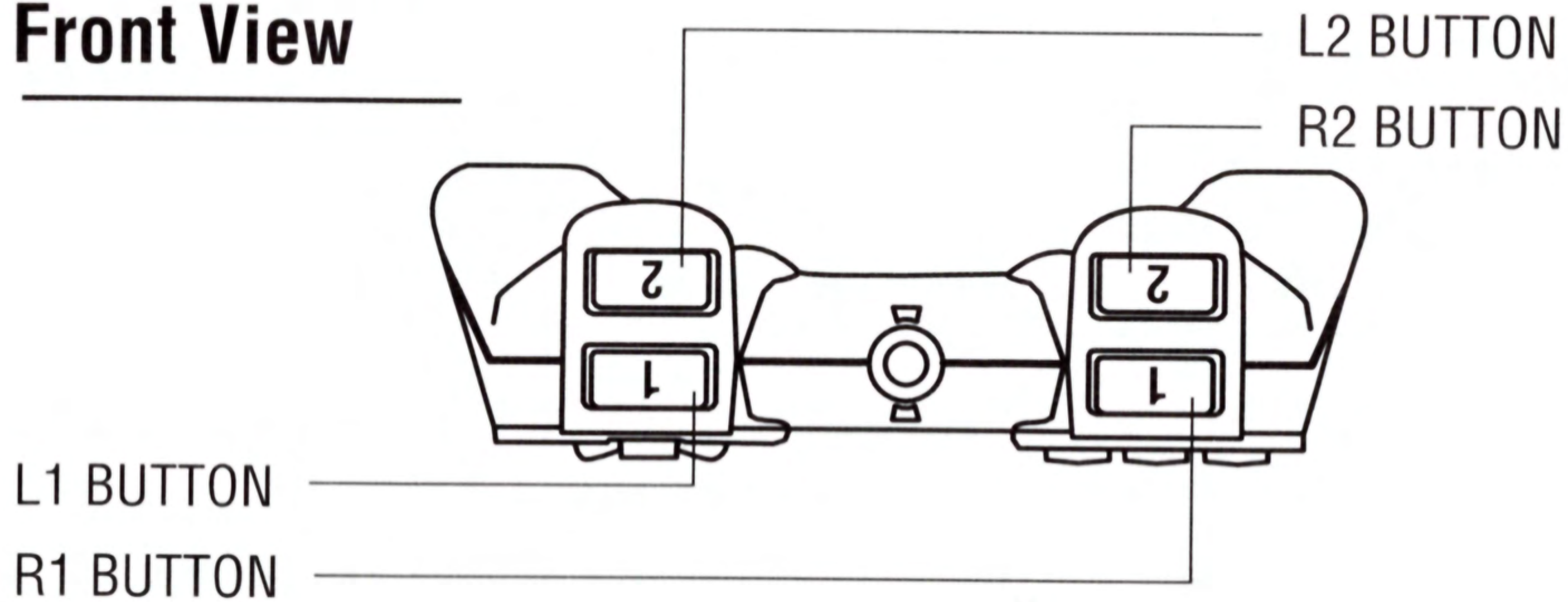

Top View

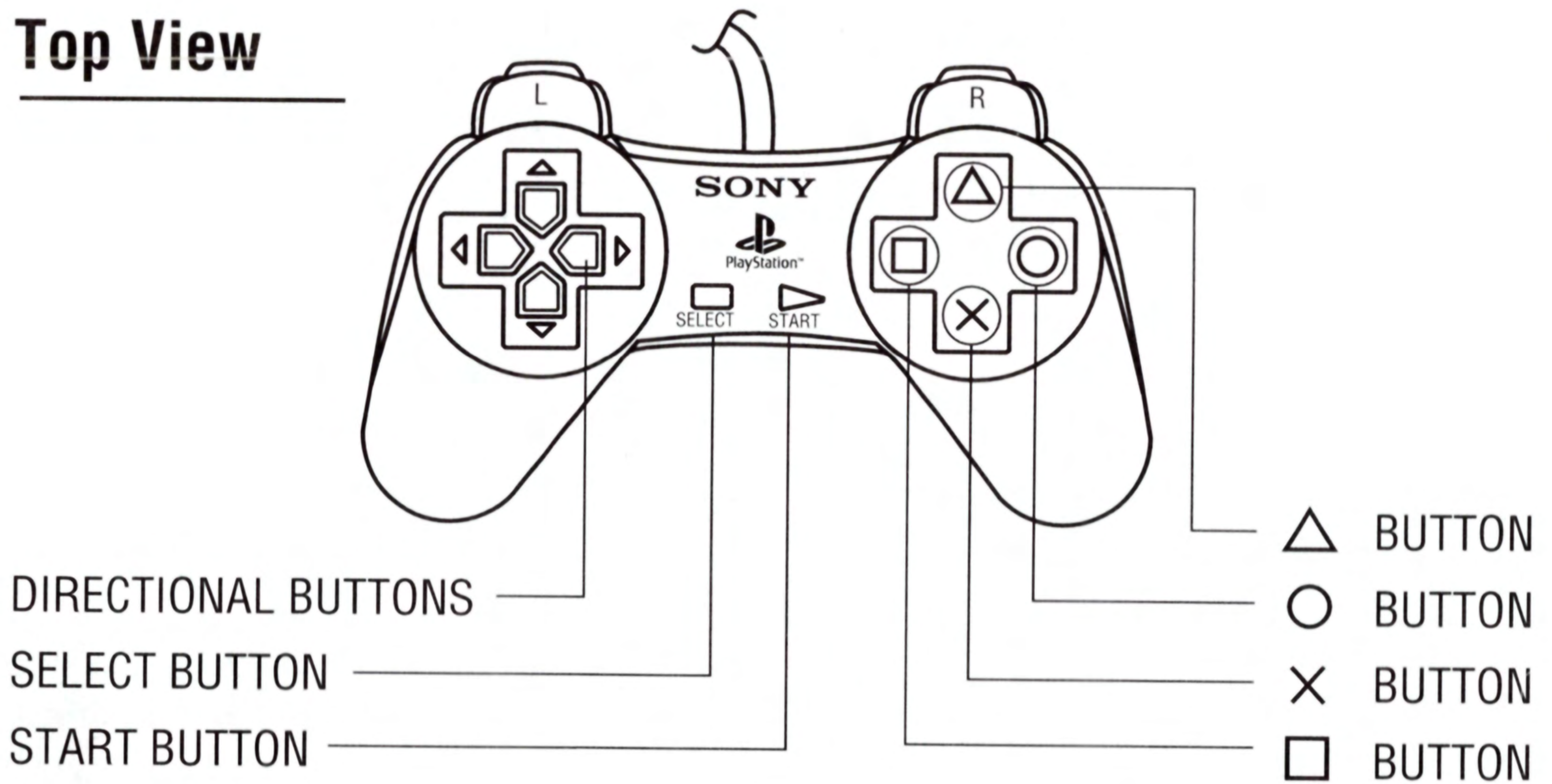

PRECAUTIONS WHEN USING THE ARCADE VERTICAL MODE

Normally, the arcade games can be played by using a normal monitor in the horizontal position, as well as a special type of vertical monitor designed for the arcade vertical mode. A horizontal monitor can be set on its side to achieve the arcade vertical position, but we don't recommend that you do this. The player should not play Galaxian, Ms. Pac-Man, Dig Dug, Phozon or The Tower of Druaga when a horizontal type monitor is set on its side in the vertical position. This could cause the monitor to fall and cause an injury, or it could also cause the monitor to malfunction.

These games should always be played when the monitor is in the normal upright position.

GREETINGS!

Thank you very much for visiting the NAMCO Museum today ! The NAMCO Museum is a place of fun and entertainment where you will experience a number of famous games as they were played during their glory years. It goes without saying that we have a lot of exhibits and other interesting materials showing the progress our company has achieved.

In this third volume of the NAMCO Museum series, the museum was remodeled, and the game options are easier to access. This new museum includes a theater and a library, enjoy !

first floor



RECEPTION AREA

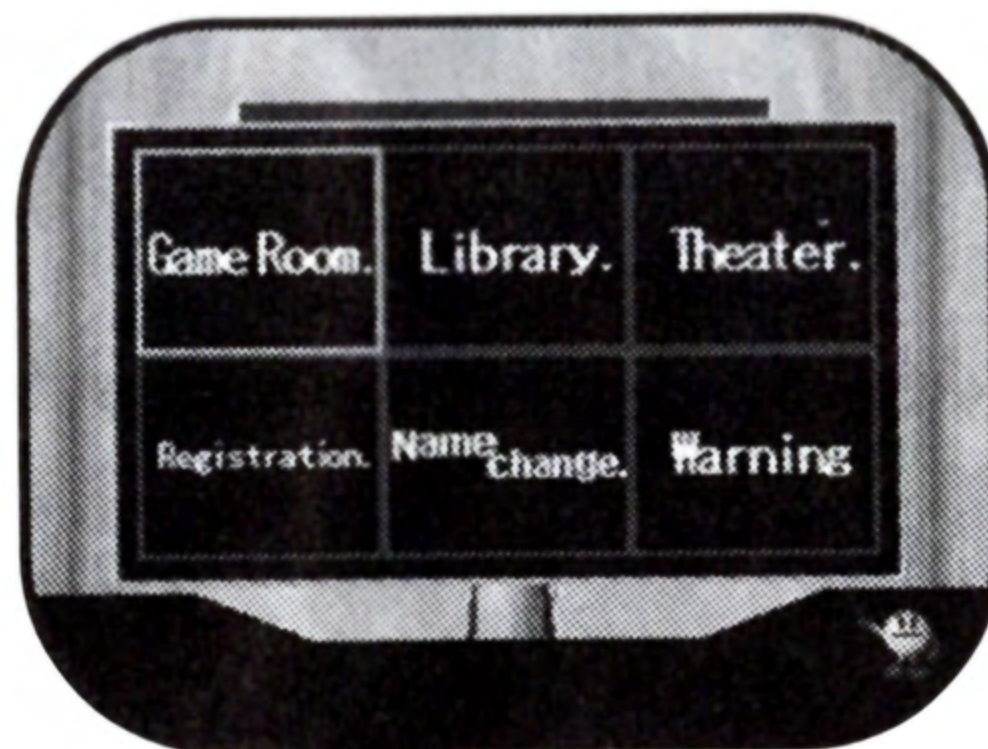

INFORMATION

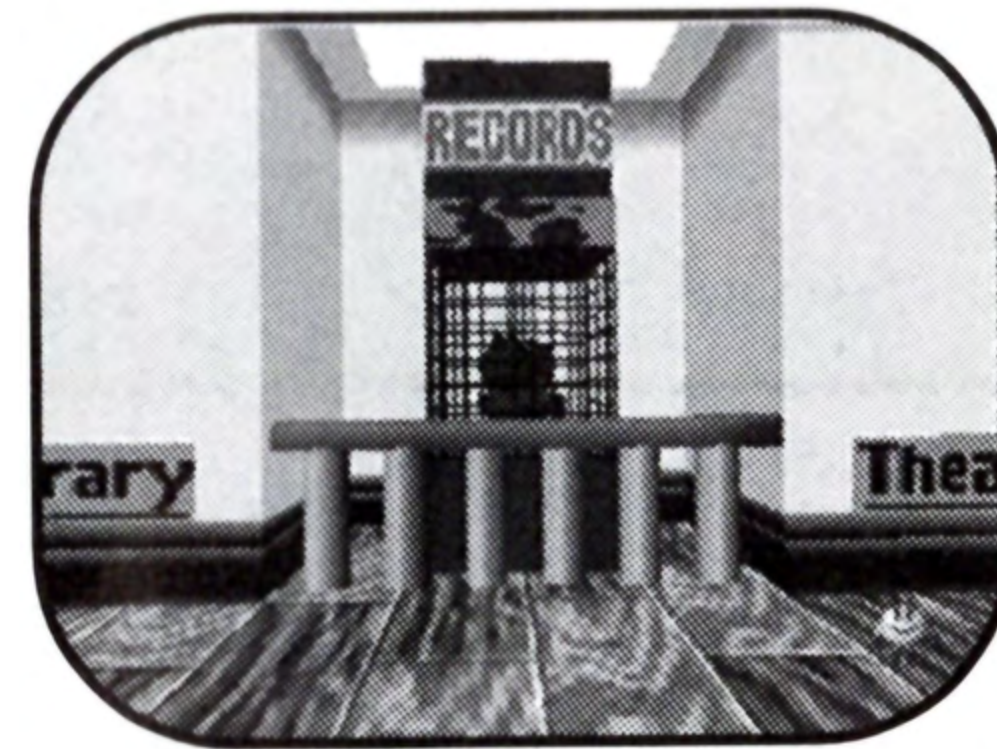

RECORD BOOK

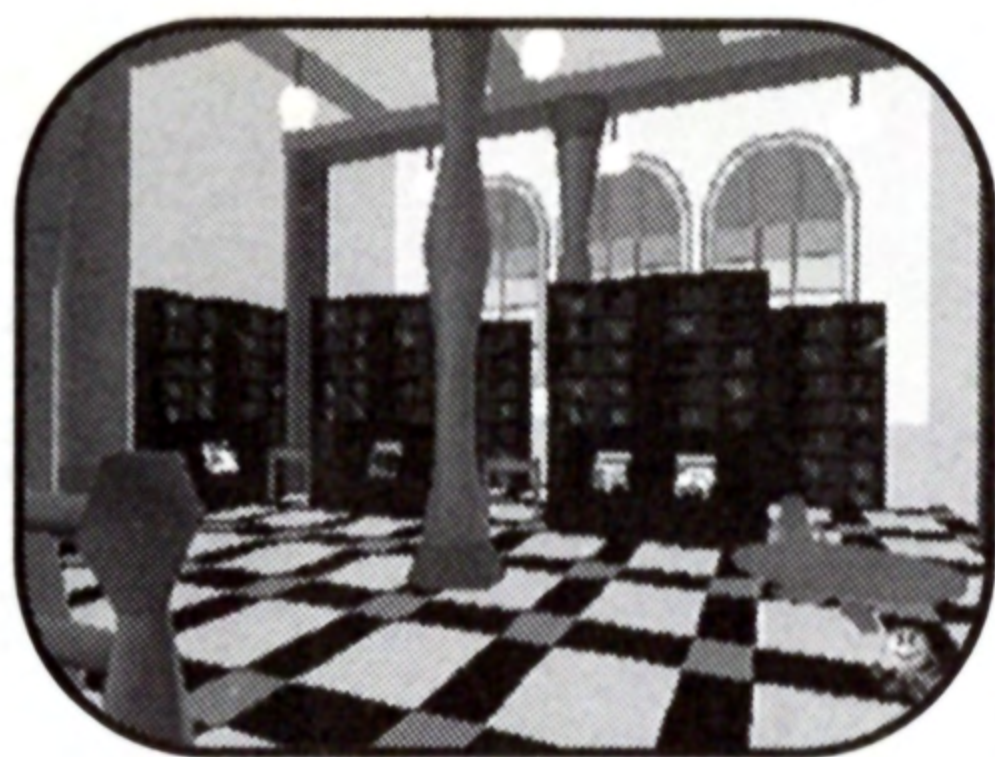

LIBRARY



THEATER

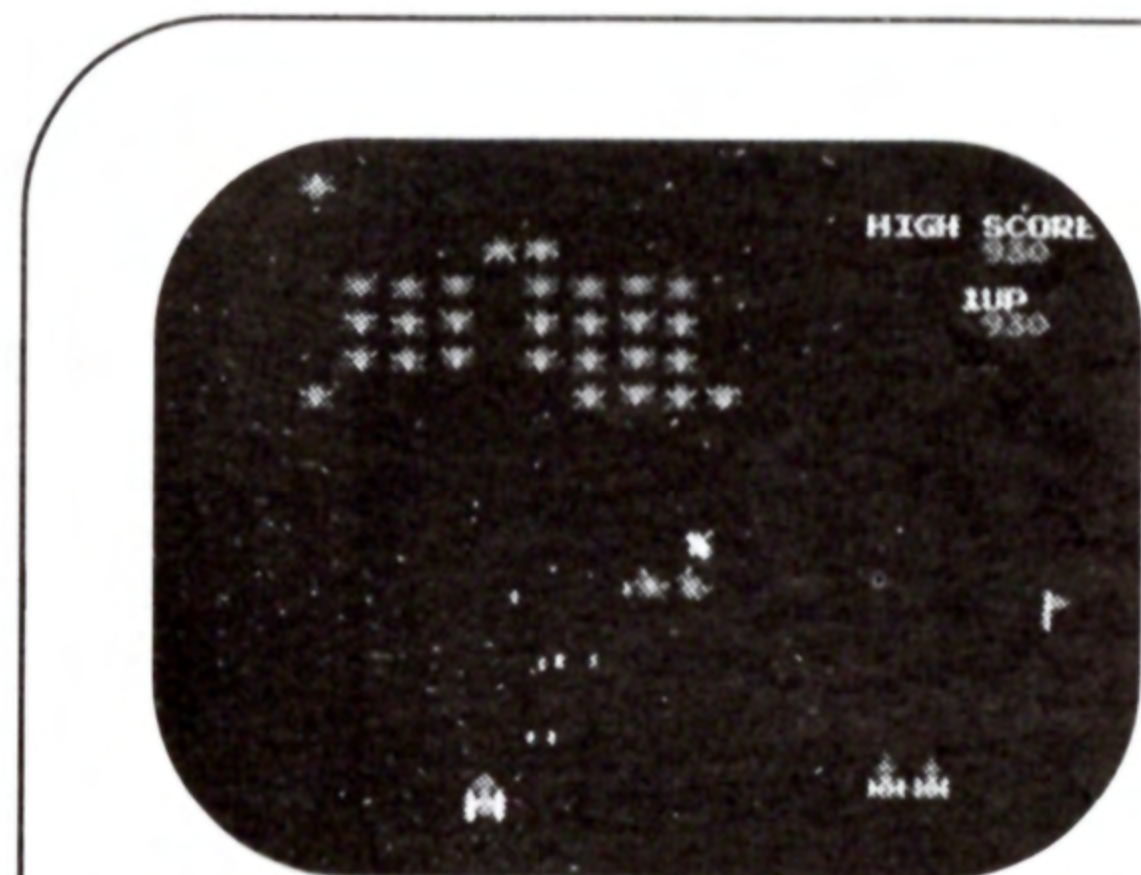

GALAXIAN

second floor

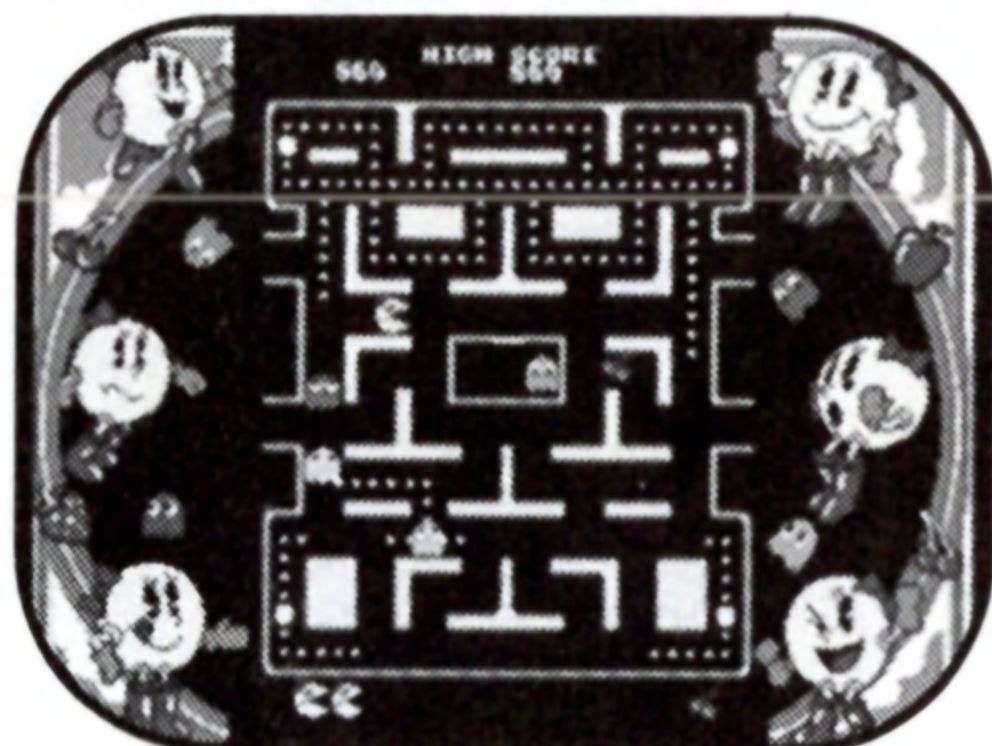

MS. PAC-MAN



POLE POSITION II

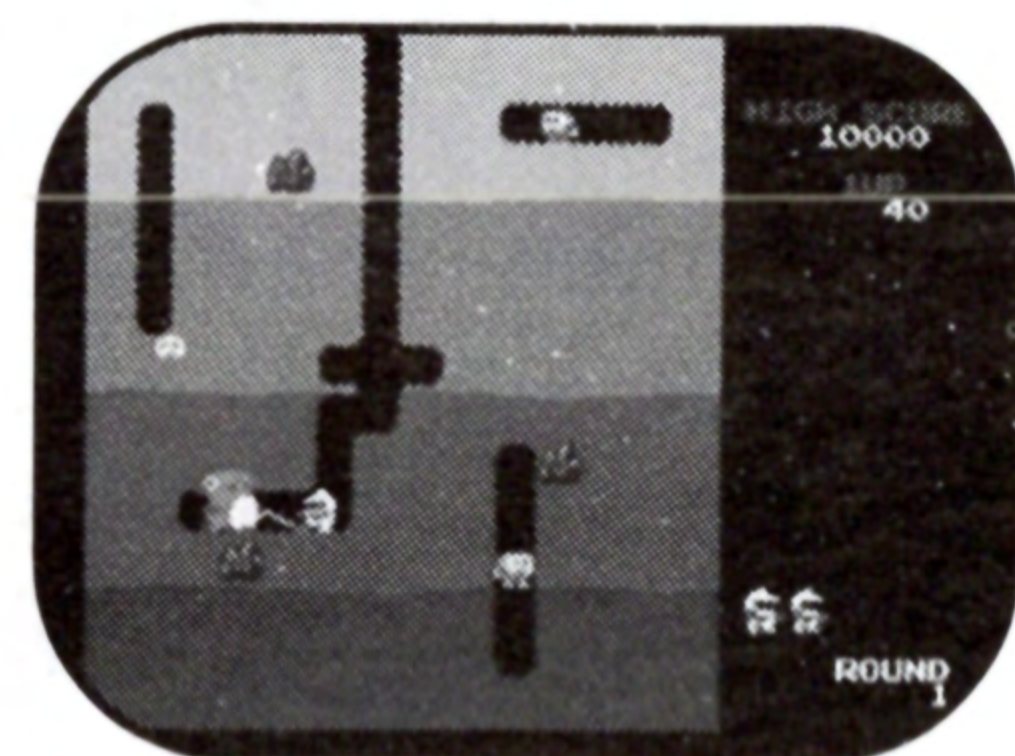

DIG DUG



PHOZON

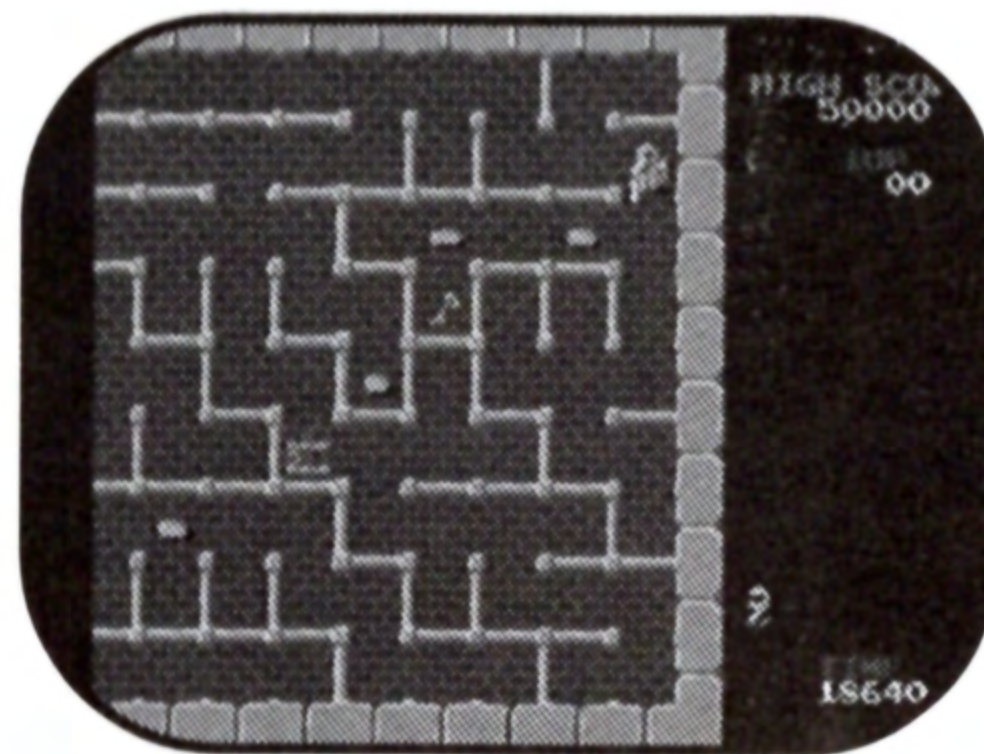

THE TOWER OF DRUAGA

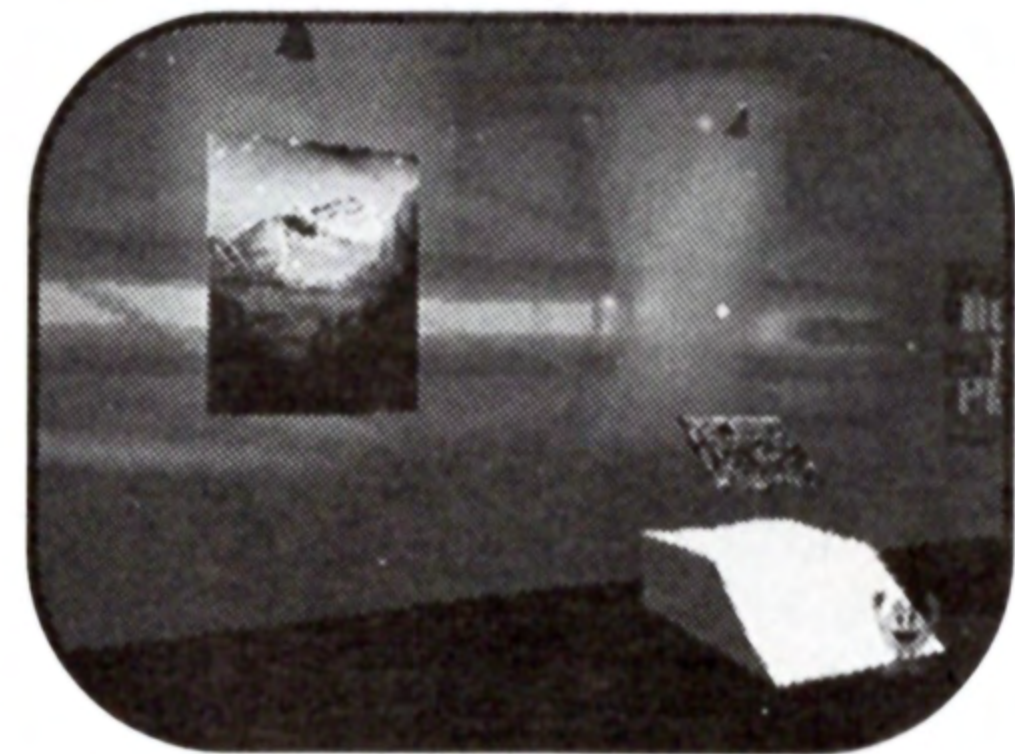

EXHIBITS

GETTING STARTED

Press the Start Button when the Title screen is displayed. You can use the Directional keys to switch between the icons displayed on the Menu screen. Press the **X** Button to determine your Mode Selection.

Museum

Select this icon to explore the museum. The screen will change to display the inside of the museum. The player can look at the items exhibited in the museum and select which of the six respective games to play.



MENU SCREEN

Games

Select this icon to play a game. The game can be played as soon as a game icon is selected from the Games Select menu. Selection is made with the Directional keys and confirmed with the **X** Button. [**RECORD BOOK**] will show you your game records. [**EXIT**] will return the player to the Title screen.



GAMES SELECT MENU

Stereo / Mono

Select this icon with the **X** Button for Stereo or Mono mode.

BASIC COMMANDS INSIDE THE MUSEUM

The commands used inside the museum are explained below. Please read the explanation of the game controller provided on the pages relating to the respective games.

Standard Controller

Start Button -- Press to select the Games Select menu. (This can be used to start a game immediately from any location in the museum). Select a Game icon, then press the **X** Button to choose the game.

Directional keys -- Determines movements (walk forward or backward, and turning, by changing direction to the right or left); also used for menu cursor movements.



▲ button Use to look up towards the ceiling.

X button Use to select an exhibited object or a display switch.

● button Press and hold this button to speed up movement when walking forward or backward.

neGcon Controller

Start Button -- Press to select the Games select menu. (This can be used to start a game immediately from any location in the museum). Select a game icon, then press the **I** Button to choose the game.

Directional Keys -- Determines movements (walk forward or backward and turning, by changing direction to the right or to the left); also used for menu cursor movement.

B Button -- Press to look up towards the ceiling.

I Button -- Use to select an exhibited object or a display switch.

A Button -- Press and hold this button to speed up movement when walking forward or backward.

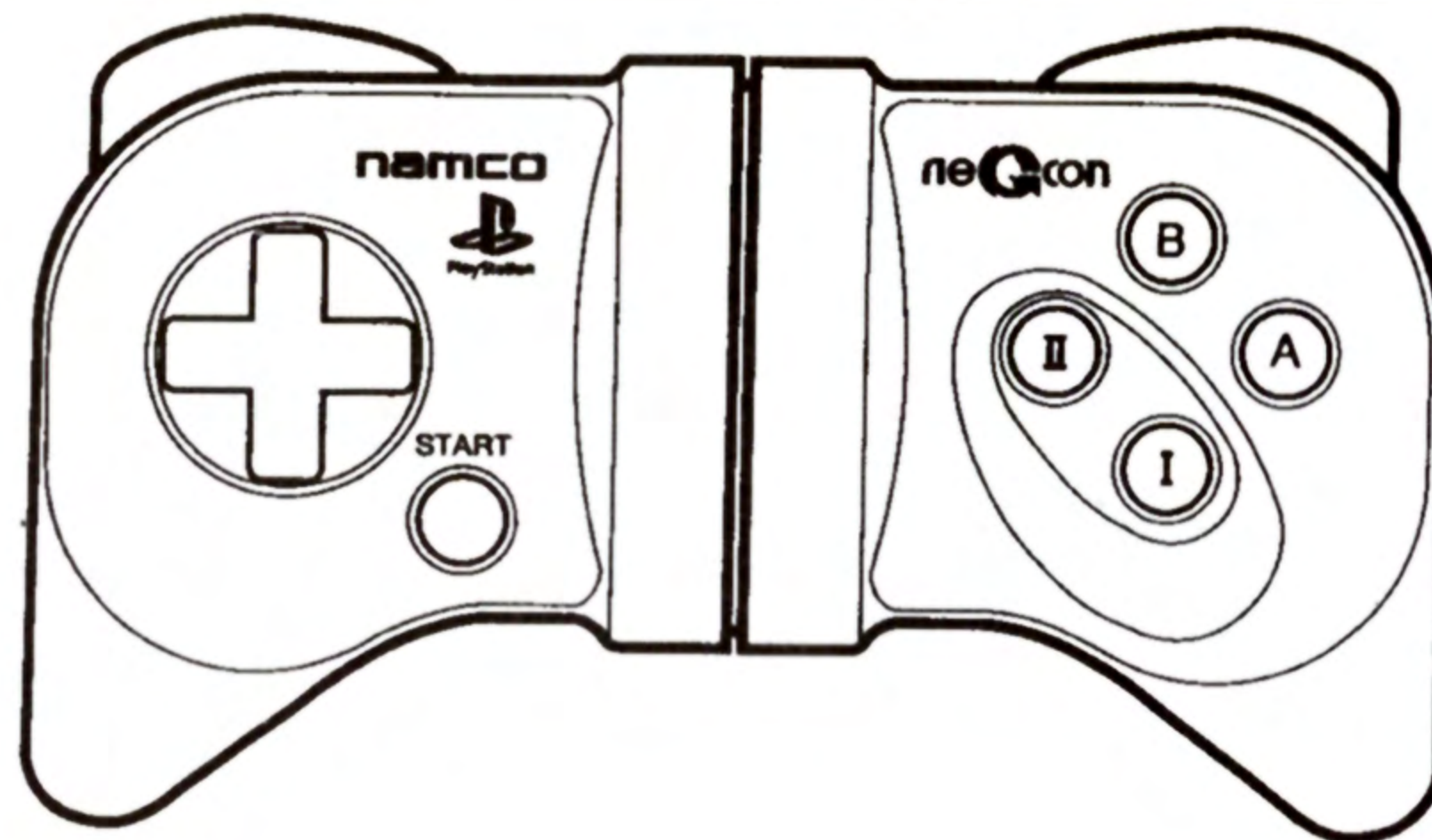

* The Directional keys are used to view an exhibit. You can get closer to an exhibit by pressing the button upward and by adjusting the direction to the left or to the right. The **X** Button can be used for an even more detailed display (the **I** Button when the neGcon is used). In addition, after getting closer to the exhibited object, you will see Pac-Man in the lower right part of the screen and he will indicate by his gestures that an exhibited object is present.

neGcon Caution: Occasionally when you first start to play a game with your neGcon, you may find that the twist control function is either oversensitive or biased in one direction, e.g. in Pole Position II, the car may veer to one side even when you're not touching the controller. Don't worry, this is not a fault with the game or the neGcon and can easily be remedied by opening the options window and calibrating your neGcon following the instructions on the key configuration screen.

FIRST FLOOR

Reception Area / Saving High Scores

After you have selected the MUSEUM icon at the title screen, you will reach the reception area to register your name. You must insert a memory card in slot 1, and register your name at the front desk with the reception girl, in order to save high scores. Once a memory card is registered, saving is done automatically when you exit a game and

return to the museum. A maximum of five people can register their names.

NOTE: A memory card, sold separately, is needed to save a registered name and high scores.

How to register your name.

Use the Directional key to select the Registration Selection, then press the **X** Button. You can select the position of the letter with the Directional key, and enter your selection with the **X** Button.

* If you come to the reception area after registration, you can change your name or register more names.

Information

Game Room / Library / Theater

You can get some information on each room here.

Registration

Register your name.

A maximum of five people can register their names.

Name Change

Change your name.

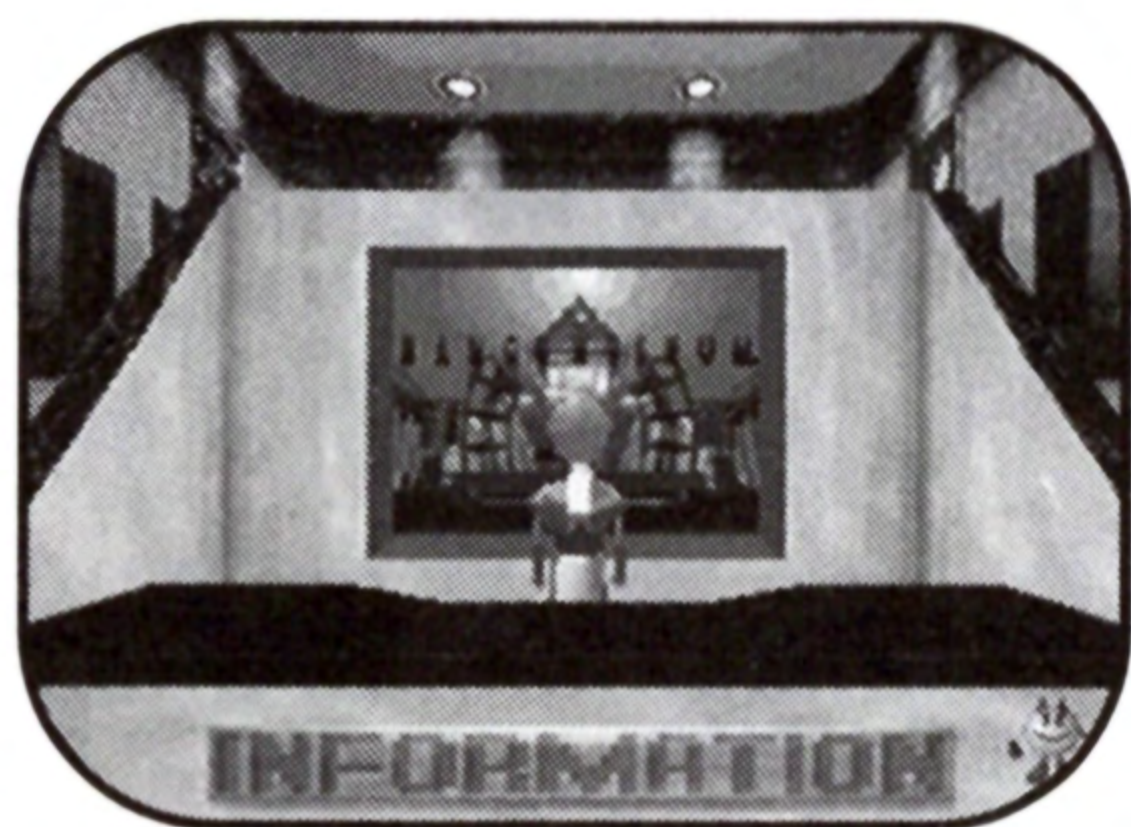

RECEPTION AREA



NAME REGISTRATION

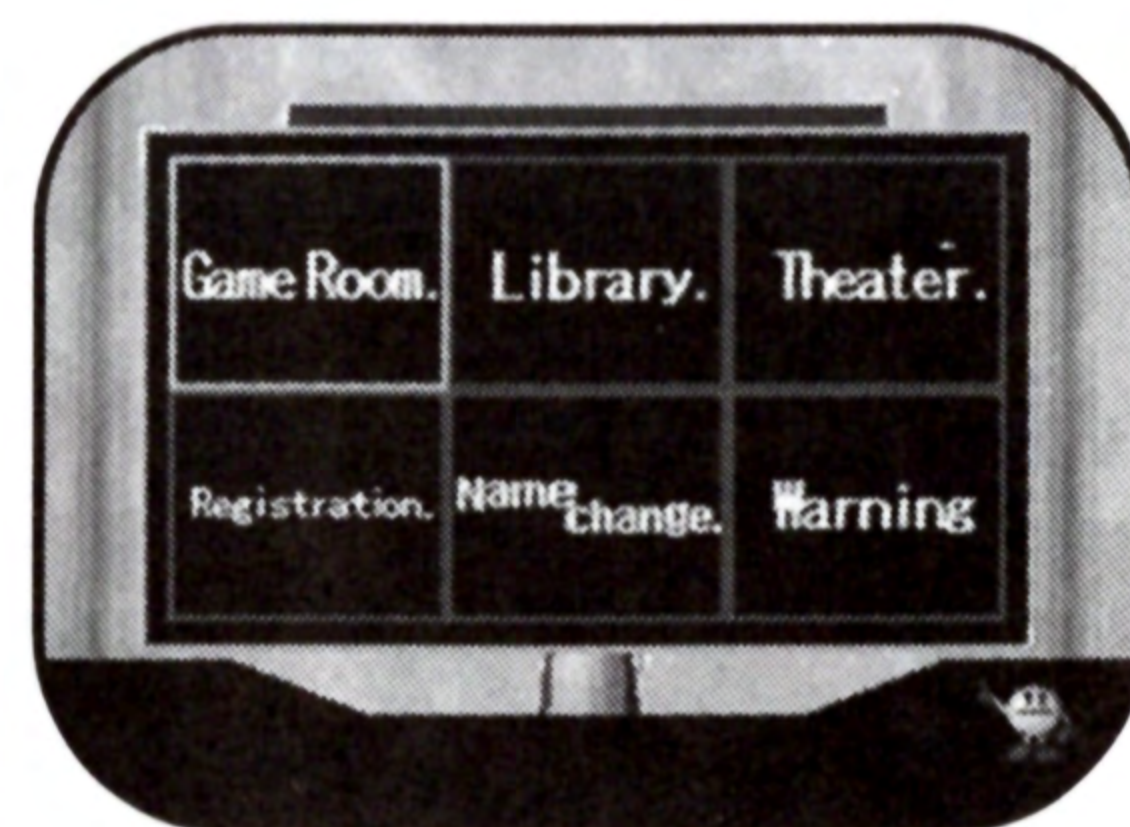

INFORMATION

RECORD BOOK

You can view the high score data saved in the memory card. To quickly get to this screen, press the Start Button then select RECORDS from the Game Select menu, and press the **X** Button. Next, highlight the player's name, the game icon, or the display switch. Make your selections by pressing the Directional key up, down, left, or right. When finished, select Exit and press the **X** Button.

↔ -- **Display switch**

Library

You can view the "NAMCO Community Magazine" display and other materials on display. To view items displayed in front of you in more detail, press the **X** Button. Use the icons below to make your selections.

↔	Display switch.
SCOPE	Used to get a closer look.
Directional Buttons	For movement.
L1/R1	To change the text display to ON or OFF.
● Button	To exit.

Theater

Use the Theater when you want to hear music, sound effects or see the slide show. First, get close to the projection screen and press the **X** Button. Next, select a game icon from the menu then press the **X** Button. When the screen changes, you can select the

sounds, music or slides by pressing the Directional keys and then pressing the **X** Button. Select "**EXIT**" to return to the Theater.

←← →→ -- Selection Switch

■ -- Stop

⇒ -- Play

EXIT -- End

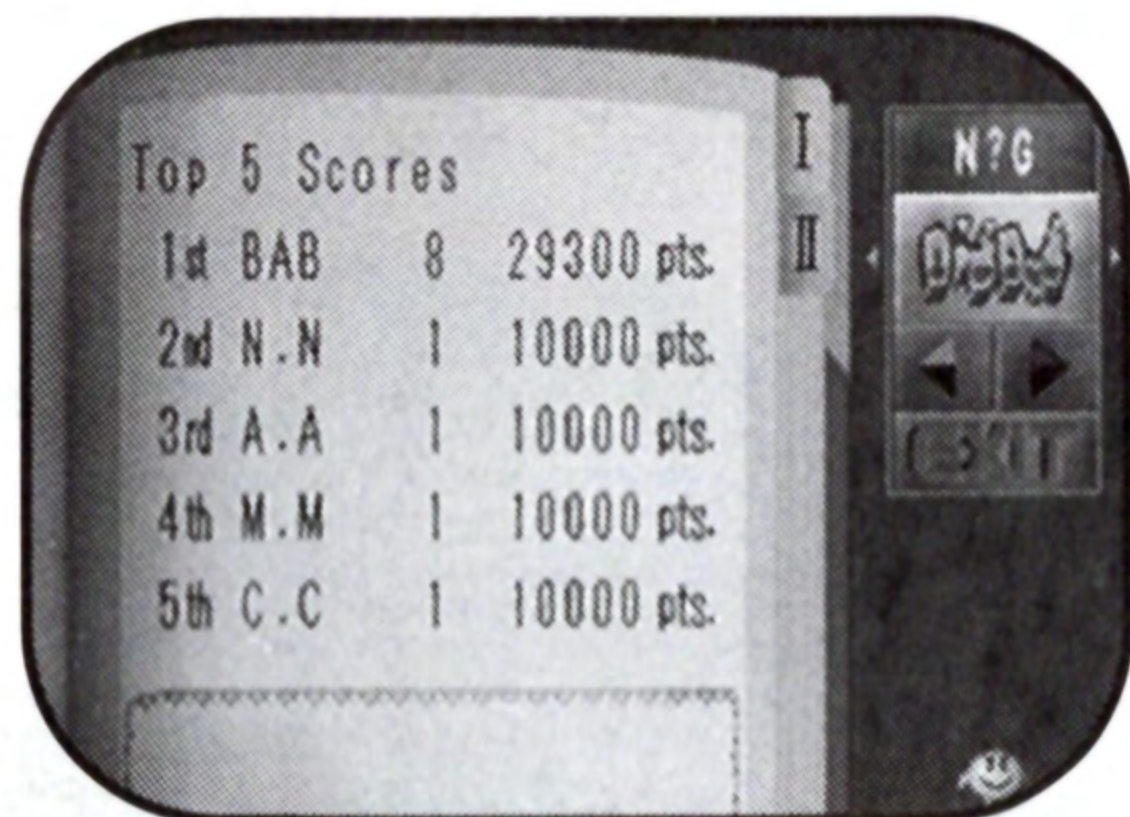

RECORD BOOK

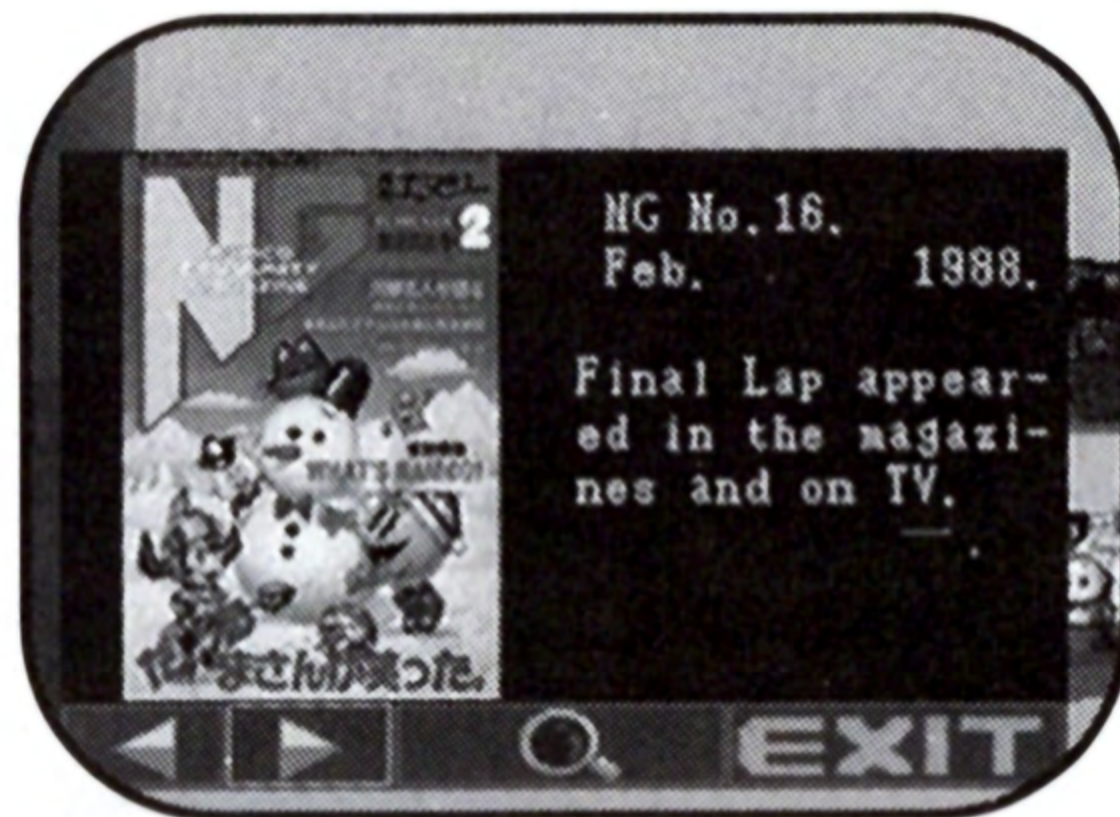

VIEWING DISPLAYED ITEMS

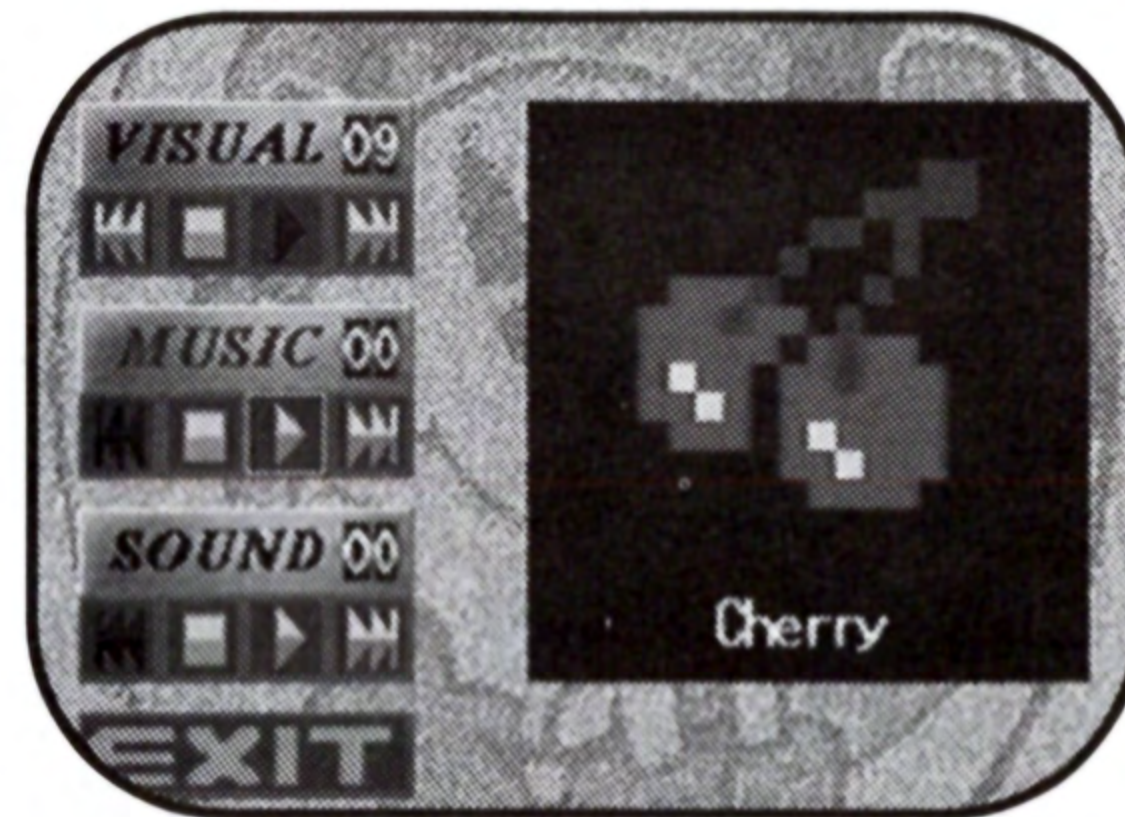

MUSIC SELECTION

SECOND FLOOR

Main Hall

The exhibit entrances for the games Galaxian, Ms. Pac-Man, Dig Dug, Pole Position II, Phozon and The Tower of Druaga are located in the center of the Main Hall on the second floor. Walk through the hallway with exhibits to reach each game room.



Hallway with Exhibits

You can see game explanations and other materials on display. Basic commands are the same as the Library's.

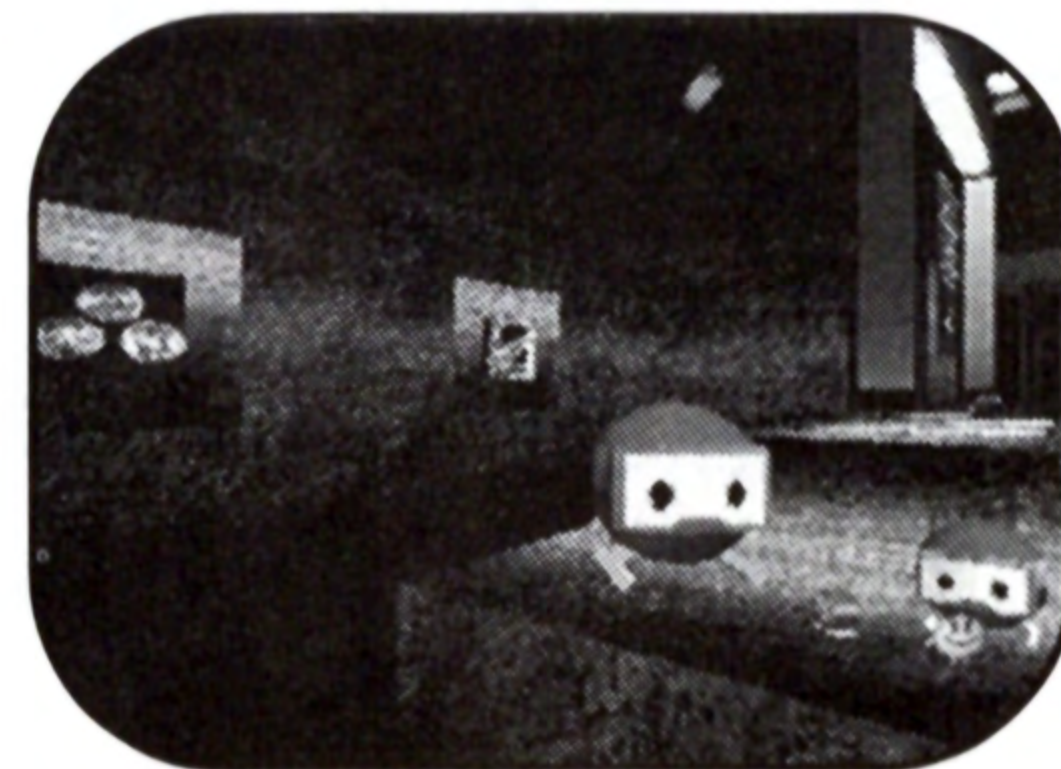

GAME ROOM

Getting Started

You can switch to the Game screen by pressing the **X** Button while standing in front of the game machine, then select the registered players data file to load the game. (If there is only one file saved, it is automatically loaded). When a flow of random letters is displayed on the screen before a game is started, this doesn't mean that the machine is malfunctioning. This function re-creates the start up of each arcade game when the power is turned on. When this is finished, a so-called cross hatch screen will be displayed. If you press the **X** or Start Button at this point, you can skip this screen and switch to the title screen.

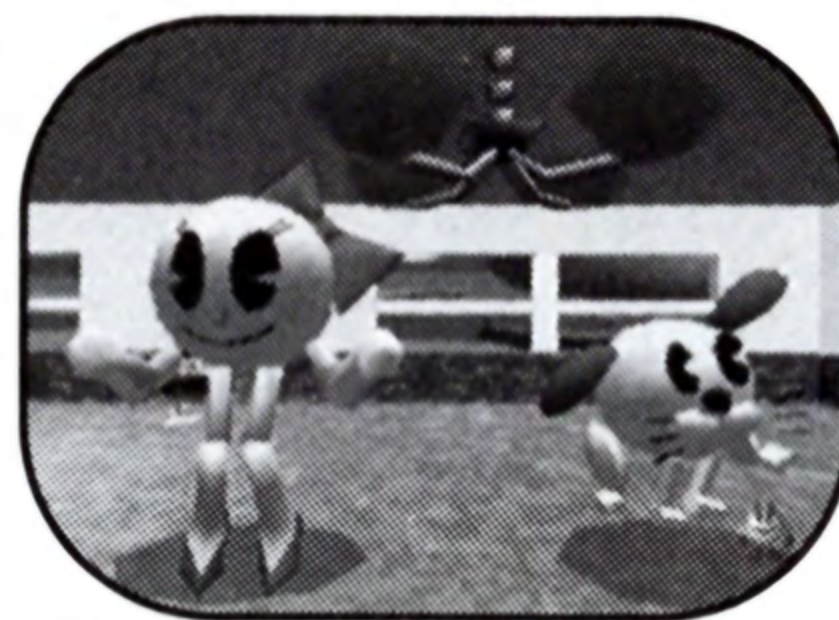

**WATCH MS.
PAC-MAN DANCE**

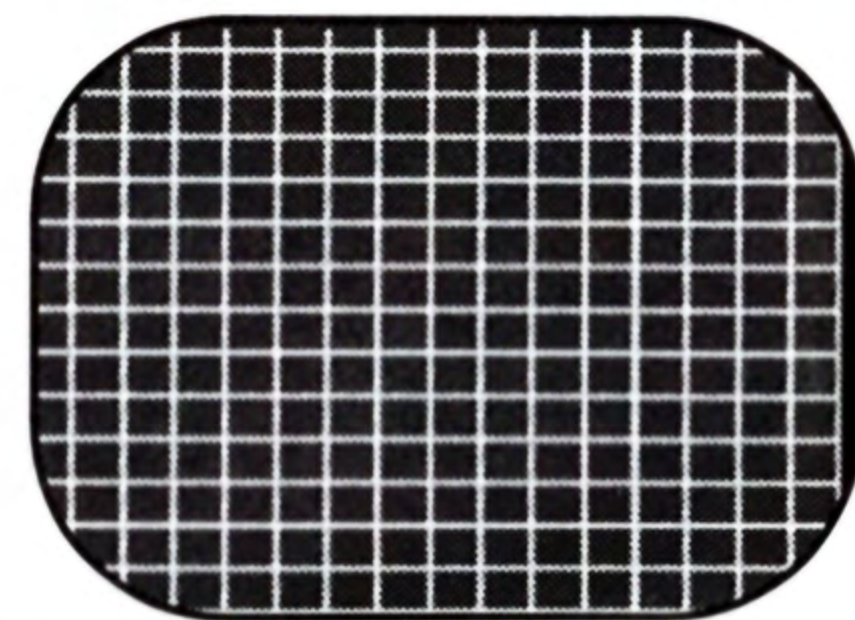

**CROSS HATCH
SCREEN**

Starting a Game

From the Title screen, enter the credits with the Select button on either controller. A one-player game can be started by pressing the Start Button. To select "**2 PLAYERS**" (when the game is played by 2 players), a second controller must be plugged into controller port 2. To select a two-player alternating game, set the credits to 2 and then press the Start Button on the controller plugged into controller port 2. Also, you can return to the museum by pressing the **▲** Button if you want to exit the game, but you must do this from the title screen. After pressing the **▲** Button, select **EXIT** from the menu and press the **X** Button then select yes to confirm your decision. During your game play you can reset the game by pressing the Start Button to pause, then press the **▲** Button. Next, select the reset command and press the **X** Button. **▲** Button -- Opens the Options Window, (see pages 13-14 for further reference) and allows you to adjust the settings for each game.

OPTIONS WINDOW

On the title screen of any of the games, press the ▲ Button to open this window. The Directional keys are used to make a selection from the menu and X Button is used to advance to the next window. To close a window, press the ● Button. Close all windows to return to the title screen.



Note : Not all options are available for each game.

SCREEN	MODE	NORMAL or ARCADE.
	POSITION	Adjust the position of the screen.
	PICTURE	Game screen border picture ON or OFF.
	SCROLL	Switch the screen scrolling ON or OFF. (Dig Dug)
	CONTROL	NORMAL or ROTATE
	CONTINUE	ON or OFF. (Dig Dug)
	ATTRACT	Demo Sound / Music ON or OFF.
	EXTEND	Extra Time. (Pole Position II)
	PRACTICE	Level of qualify. (Pole Position II)
	TIME	Qualifying lap time. (Pole Position II)
	GOAL	Laps to goal. (Pole Position II)
	SPEED	kmh or mph. (Pole Position II)
KEYCONFIG		Change the button settings. (Pole Position II)
OPTION	GALAXIP, MS. PAC-MAN, DIG DUG, CHEMICS & GIL	Lives in reserve.
	BONUS	Extra Life.
	RANK	Difficulty Level.
	PAUSE	ON or OFF.
	SOUND	ON or OFF.

TEST	SCREEN	On this screen, you can listen to the sound test. Press the ▲ Button on the test mode screen to enter the dipswitch screen.
	DIP SW	Switch any switch with the Up or Down key to change the settings as you wish. Note : It's not really necessary to adjust the game options from here, since they are easily accessible through the Options Windows.
	GAME	Goes back to the Title Screen.
EXIT	Goes back to the museum.	
RESET	Reset the game.	



How to Use the Controller

Directional Buttons	Moves your fighter to the left or right.
▲ Button	Opens the Options Window (only from the Title screen).
Select Button	Enter credits.
Start Button	Use to start, pause or unpause the game.
■ / X / ●	Buttons launch missiles.

How to Play the Game -- The formations will attack you, one after another, when the game starts. Your mission is to kill all the enemies to proceed to the next stage.

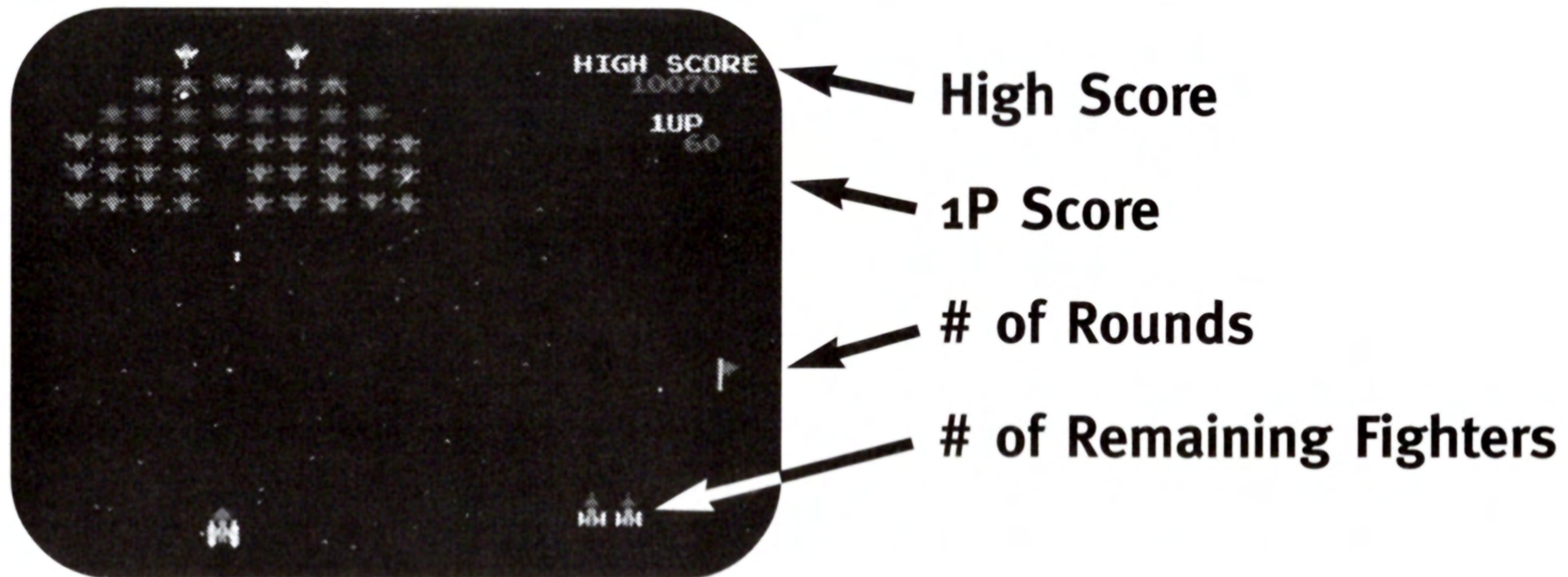

Rules

- You will lose one star fighter when you are hit with an enemy's missile or when you touch the enemy.
- When you lose all the star fighters, the game is over.
- One star fighter will be awarded by scoring 5,000 points. (This value is set in the initial setting and it can be changed with the Bonus option).

Tips

- Kill the escorts ! - The boss with one escort is 200 points, with two is 300 points. Kill both escorts first to get 800 points.
- If you take too long to destroy the formation, or there are only a few enemies left, they will start attacking very aggressively. Kill the enemies quickly !



How To Use the Controller

Directional Buttons	Press to move Ms. Pac-Man through the maze.
▲ Button	Opens the Options Window (only from the Title screen).
Select Button	Enter credits.
Start Button	Use to start, pause or unpause the game.

How To Play the game - The purpose of the game is to eat all the pellets (•) from each maze while avoiding the attacks of the four ghosts. When all the pellets are eaten up, the player can proceed to the next round.

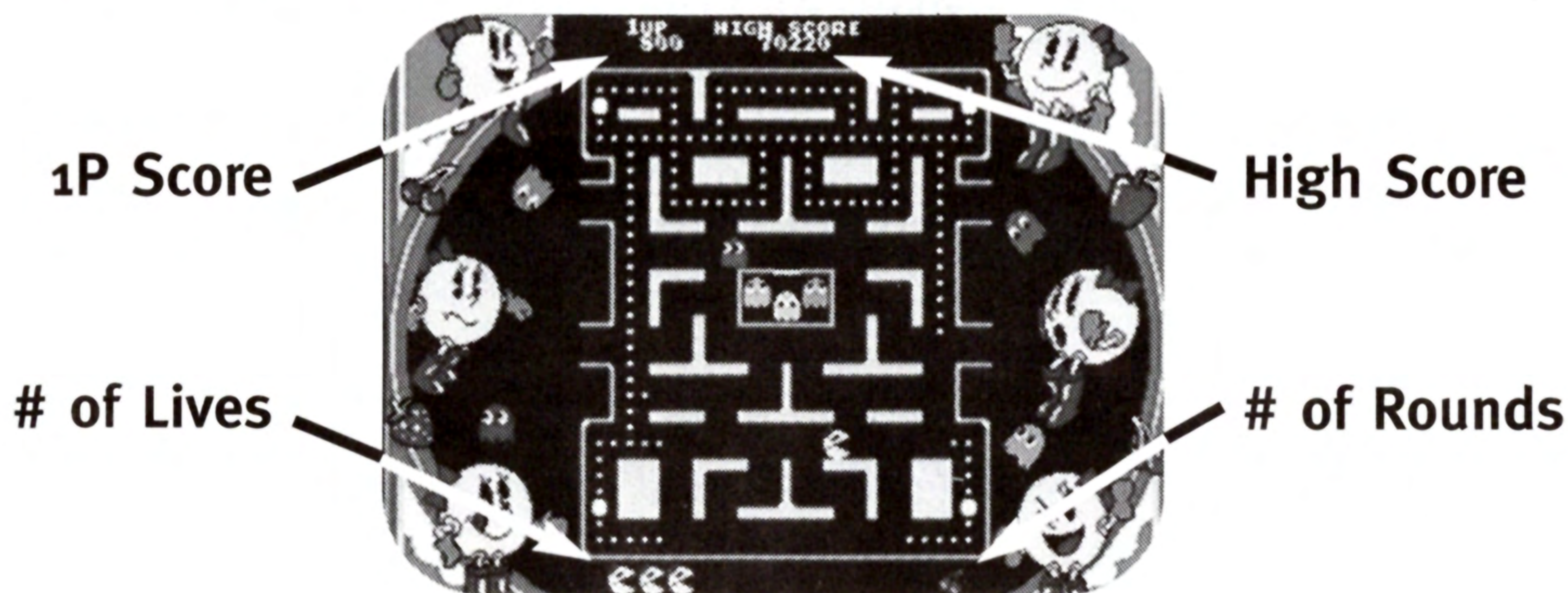

Rules

- If you touch a ghost, Ms. Pac-Man will lose one life.
- The game is over when all the lives are lost.
- An extra life is awarded by scoring 10,000 points. (This value is set in the initial setting and can be changed with the Bonus option).

Power Pellets - Chomp down a power pellet, and Ms. Pac-Man will have the power to eat ghosts. When a power pellet is eaten, the ghosts' color changes to dark blue for a short time. The ghosts will start flashing before they turn back to their normal color, so watch out! After a ghost has been eaten, its eyes will return to the ghost zone, and the ghost will be regenerated. The more ghosts you eat in succession, the more points they are worth.

Fruit Treats - Fruit will appear twice in each maze, munch these for bonus points. The more mazes you complete, the more the fruit is worth.

Warp Tunnels - Go through these tunnels and you'll shoot out on the other side of the maze. Use them to slow down and lose a ghost that's hot on your tail.





How to Use the Controller

Directional Buttons	Moves DIG DUG in one of four directions.
▲ Button	Opens the Options Window (only from Title screen).
Select Button	Enter credits.
Start Button	Use to start, pause or unpause the game.
■ / X / ●	Use your pump to pop and kill the enemies. Press multiple times to pop enemies.

How to Play the Game - Move DIG DUG and dig up the ground layers, then use your pump to pop and kill the enemies or crush them with rocks, while avoiding their attacks.

Rules

- You will lose a life if you are caught by the enemies, touch Fygar's fire, or get crushed by a rock.
- The game is over when all the lives are lost.
- An extra life will be awarded by scoring 20,000 points and 60,000 points. (This value is the default setting, it can be changed by adjusting the Bonus option).
- The continue screen will appear when the game is over. You can continue playing the game by holding any pump button, then press the Start Button before the countdown reaches zero. Make sure you enter a credit first.

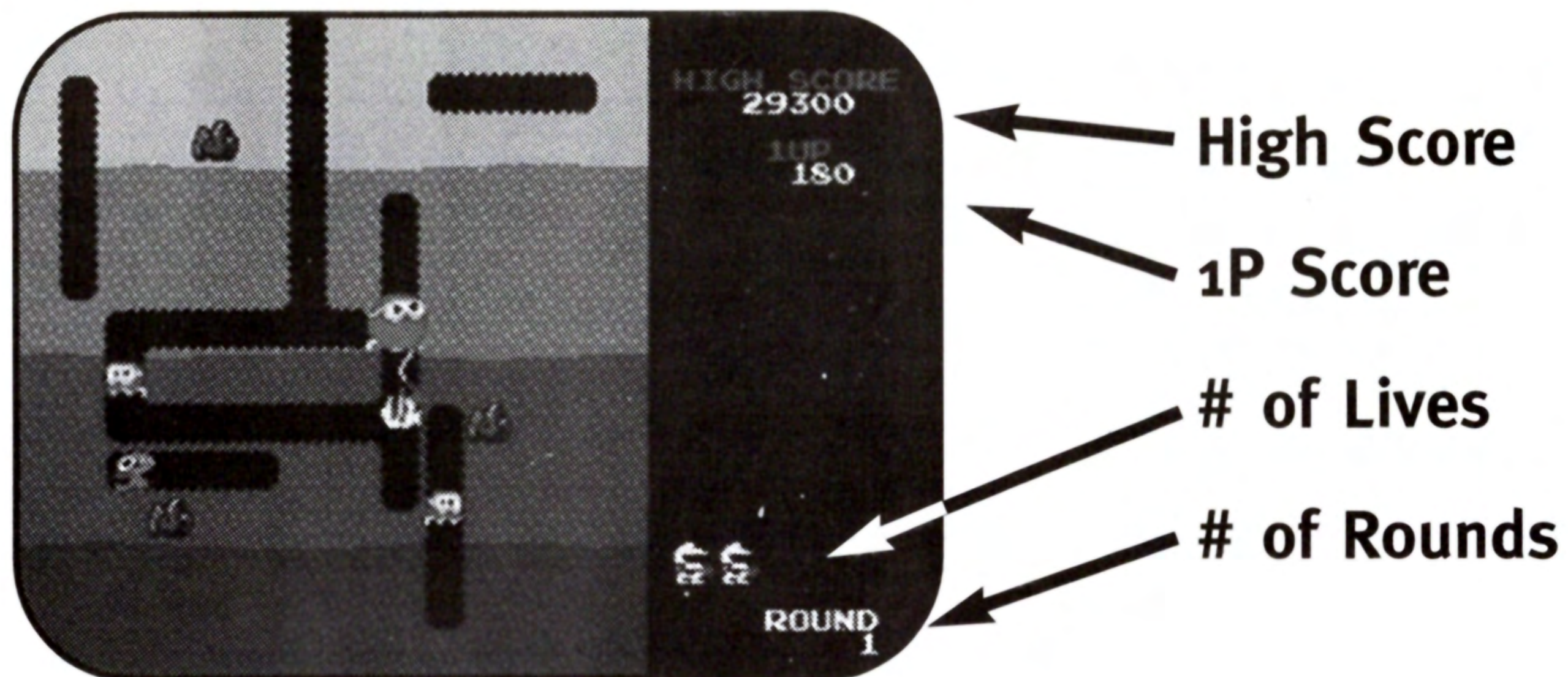

Vegetable Treats - A vegetable treat will appear if you drop two rocks on each round. The more stages you clear, the more the vegetable treats are worth.

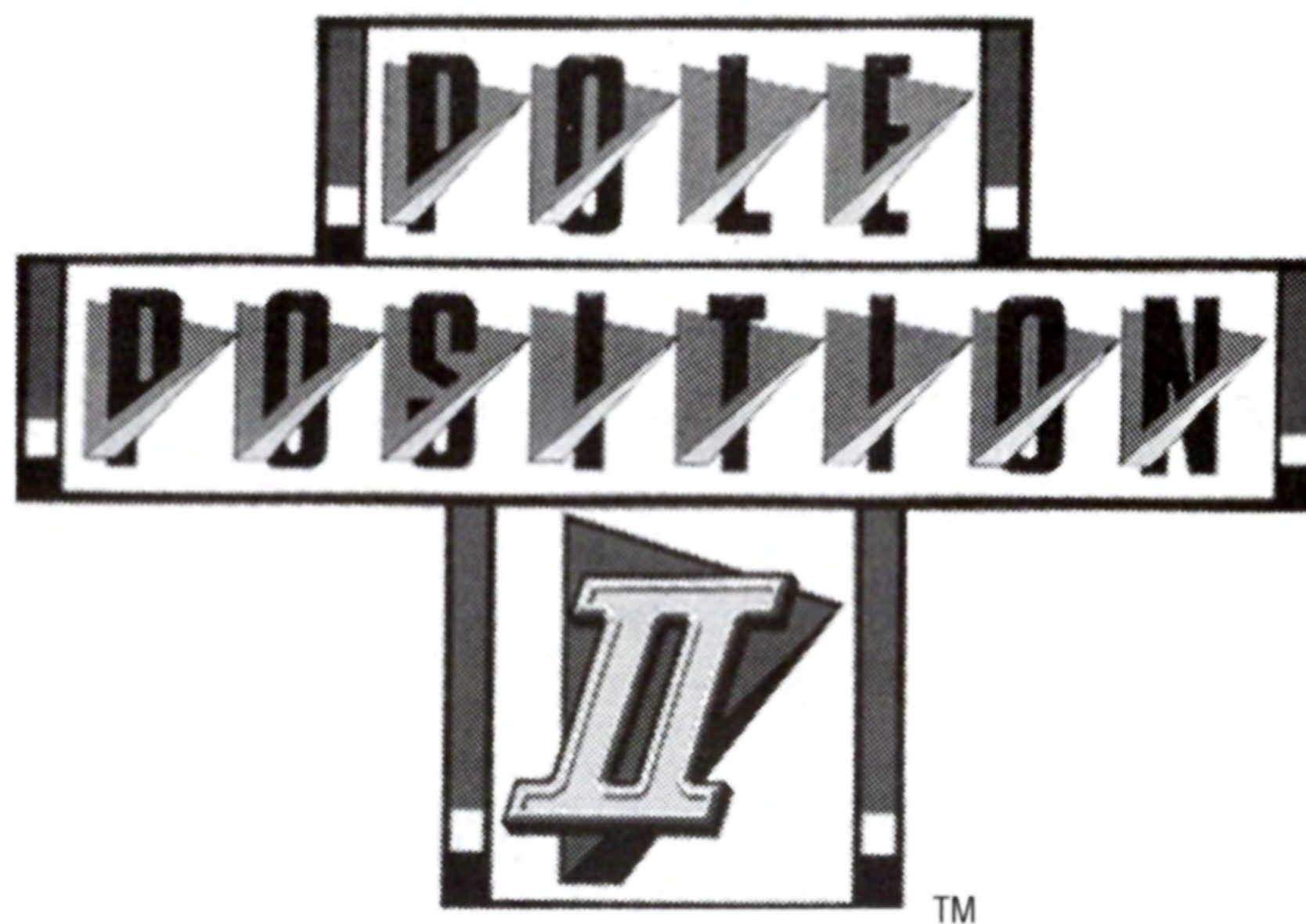

How to Use the Controller

L1/L2

Shift up (High Gear)

R1/R2

Shift down (Low Gear)

Directional Buttons	Steer car to the left or right.
▲ Button	Opens the Options Window (only from Title screen).
Select Button	Enter credits.
Start Button	Use to start, pause or unpause the game.
X Button	Accelerator
■ Button	Brake

How to Use the neGcon Controller

Twist controller	Steers car to the left or right.
Start Button	Use to enter credits, start, pause or unpause the game.
Directional Buttons	When pressed up, shifts down (Low Gear) When pressed down, shifts up (High Gear)
B Button	Opens the Options Window (only from the title screen).
I Button	Accelerator
II Button	Brake

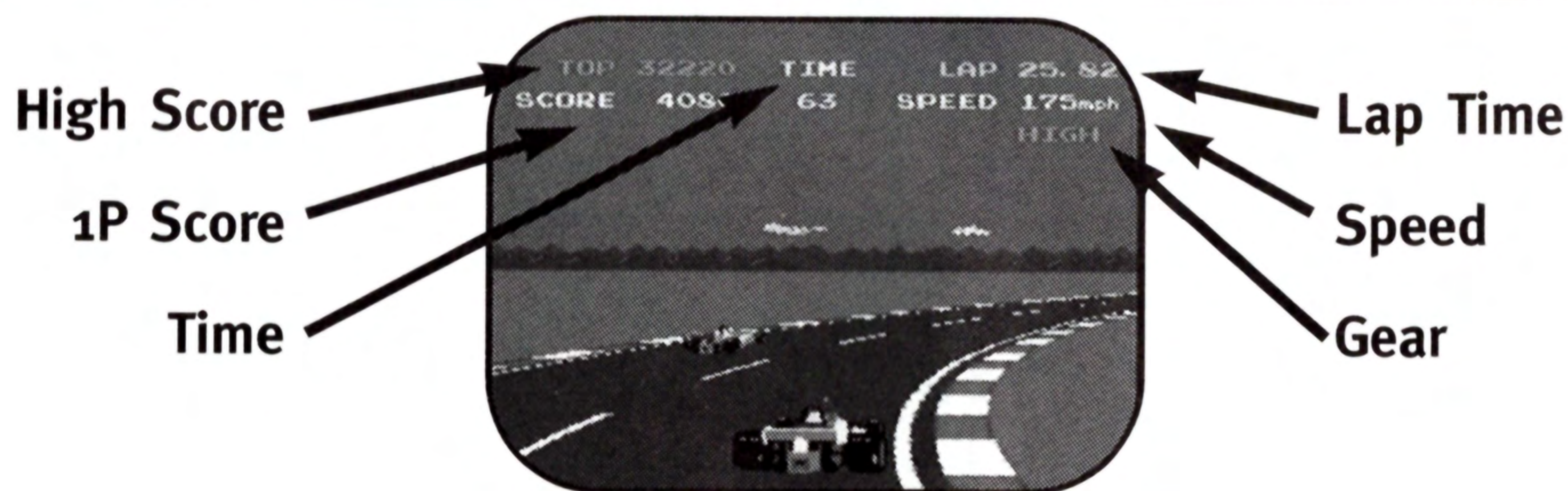

How to Play the Game - After pressing the Start Button on the title screen, press the Directional Keys to the left or right to choose one of four different race tracks, then press Start. Use the controller as mentioned to control your car's steering, acceleration, braking, and the shifting of gears.

First, you must qualify for the main race (Grand Prix) by completing one lap with a fast lap time. If successful, when you cross the Start / Finish line after completing the lap, you will receive your starting position for the main race. If you take too long, or crash on the qualifying lap, you won't qualify for the main race, and the game will be over.

When starting the main race, you will begin from the position that you qualified. You must successfully complete four laps to finish the race. As the race progresses, you should avoid crashing into other cars, or obstacles on the sides of the racetrack. Also avoid driving over water puddles, since these slow you down. You will receive additional race time, for each lap that you complete by crossing the Start / Finish line. In the main race, if the time reaches zero before you cross the Start / Finish line, the game will be over.

Tips - If you drive over water puddles at 370 kmh, you will have turbo charged power.

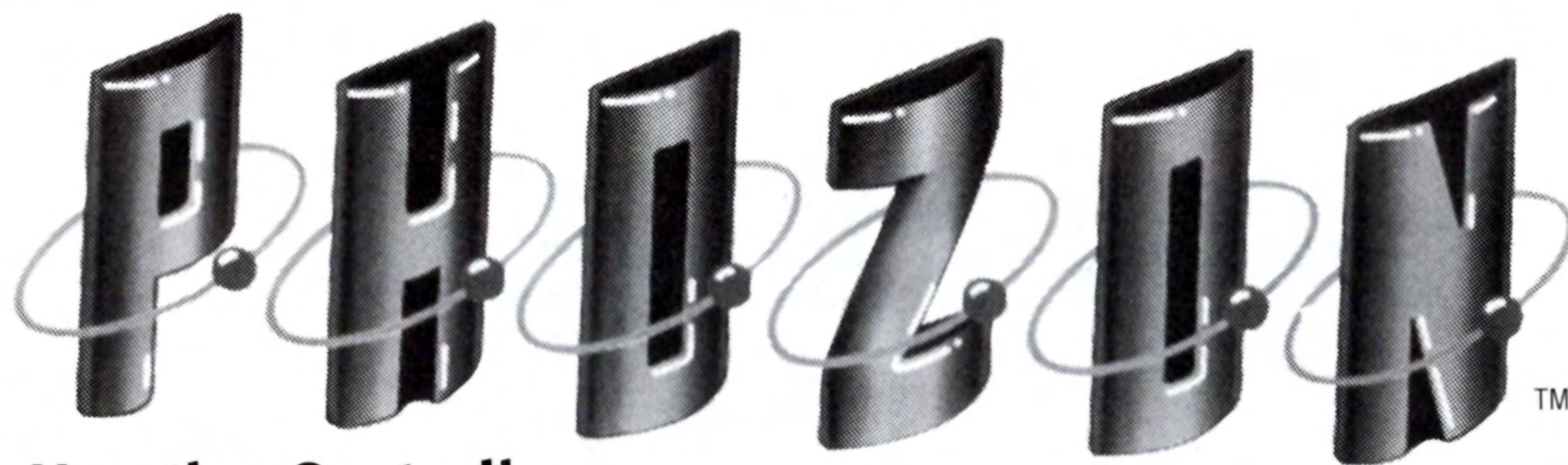

How to Use the Controller

Directional Buttons	Moves the CHEMIC in one of eight directions.
▲ Button	Opens the Options Window (only from Title screen).

Select Button	Enter credits.
Start Button	Use to start, pause or unpause the game.
■ / X / ●	Use to release "MOLEK."

How to Play the Game -- Move the CHEMIC and catch the floating MOLEK to complete the formation to go to the next round. Each world consists of 3 stages. You will lose one life if you touch the ATOMIC. A limited number of MOLEK appear on each stage. The challenging stage will appear every 3 stages. If one or more MOLEKS are attached to your CHEMIC in the wrong position, you can shoot them away by pressing the ▲, X or ● Buttons. You can also shoot MOLEKS to destroy some of the enemies. You must complete the pattern like it is in the background to complete a stage.

Game Characters

- Chemic** The core used to make the formation.
- Molek** Catch the same color Molek to get more points.
- Power Molek** You can attack the Atomic for a short time.
- Atomic** Splitting or in one piece. If Chemic touches this, one life will be lost.
- α-ray** Destroy three pieces of Molek if touched.
- β-ray** Destroy one piece of Molek if touched.

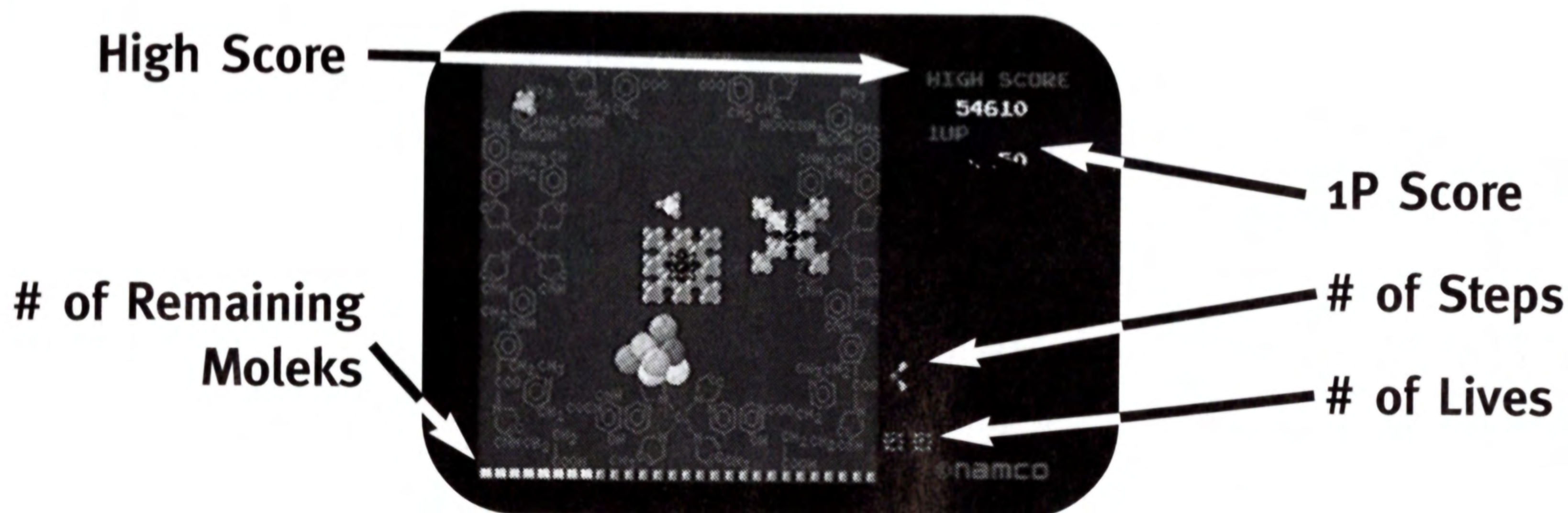

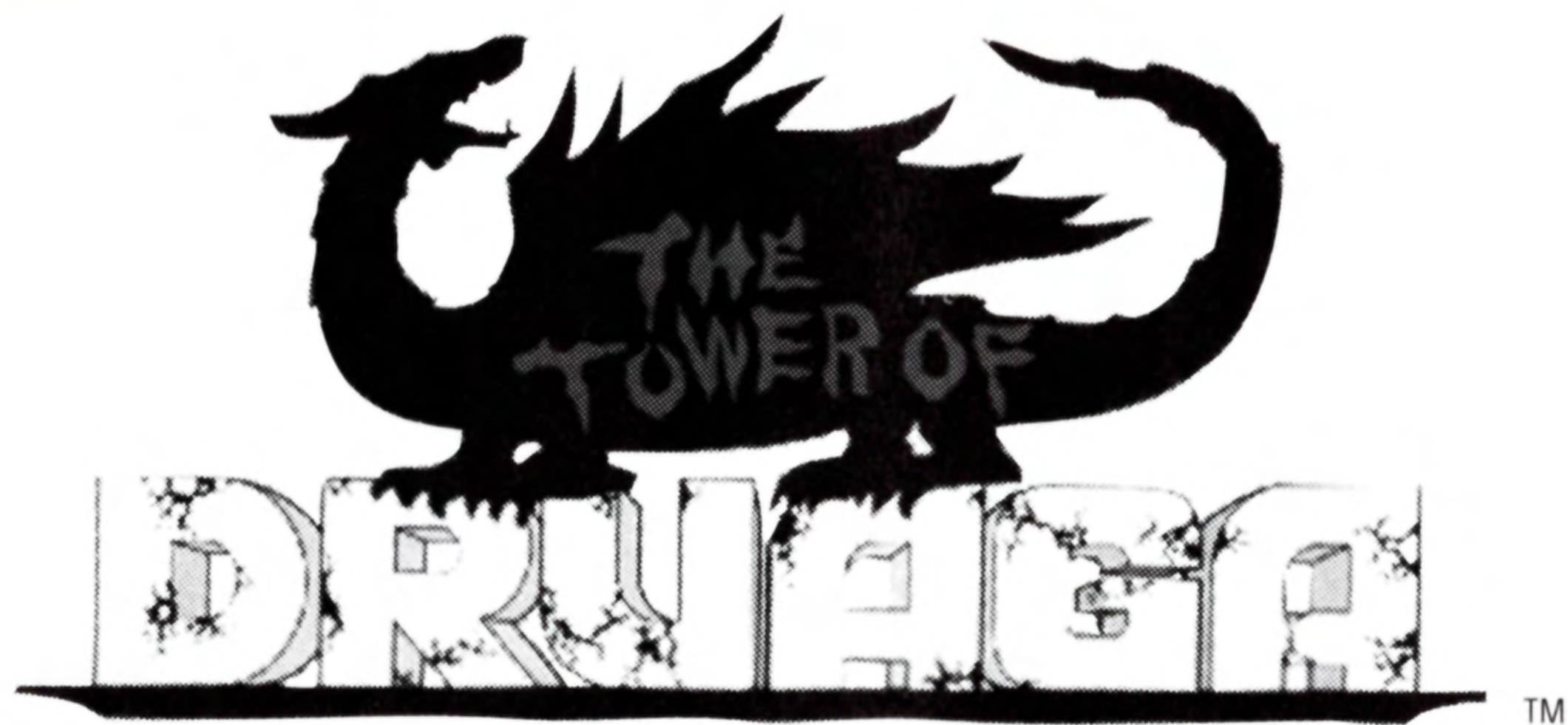

How to Use the Controller

Directional Buttons	Moves "GIL" in one of four directions.
▲ Button	Opens the Options Window (only from Title screen).
Select Button	Enter credits.
Start Button	Use to start, pause or unpause the game.
■ / X / ●	Swings the sword.

How to Play the Game - Attack the enemies with your sword and block spells with the shield. Find the key to unlock the door and exit the floor.

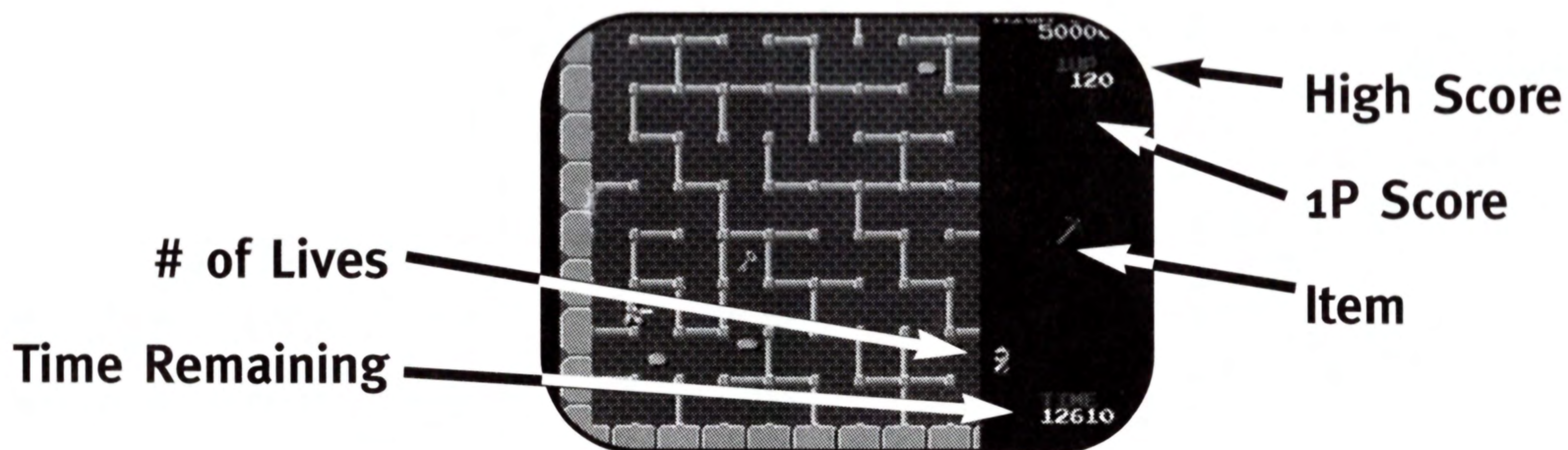

Rules

- You will lose a life if you are caught by the enemies, touch an enemy's projectile, etc.
- The game is over when all the lives are lost.
- One extra life will be awarded by scoring 50,000 points. (This value cannot be changed).

Continue (One player mode only) - After game over, enter the credits, then press and hold the ● / X or ■ Buttons, then press Start Button. When the message "**SELECT START FLOOR**" appears, select the floor that you want to play by using Up or Down Directional key, then press the ●/ X or ■ Buttons.

Block the spells with the shield ! - GIL can block the enemy's spells from the front in the normal position. When the sword is swung, he can block only the left side of his body from the enemy's spells.

Find the Treasure Boxes ! - There is a treasure box that will appear on each floor if you do a certain command. An item that is necessary to clear the game is inside each box. Please refer to the Item List inserted separately, which shows how to find each treasure, and tells you its special ability.

Note - The enemies rarely go over the outside wall during play and you might be forced to go back to the title screen. This was part of the original spec of the arcade version.

CREDITS

Published by: Namco Hometek Inc.
Designed and Developed by: Namco Ltd.
Namco Hometek Inc.

MARKETING

Glenn Halseth "Smiley"

TECHNICAL EDITORS & MANUAL DEVELOPMENT

Loan Vu the "Puzzle Queen"
Jeff Yonan the "Shooter King" A.K.A. "AJF"
Yuri Saito the "bitchin' guy on the Namco Video"
Jen Fitzsimmons "Fitz"

MANUAL DESIGN

Darien & Kilburg

SPECIAL THANKS

Craig Erickson the "Corvette Man"
Dave Winstead "Dr. Dave"
Mike Madden the "Mad Man"
Geoff Erickson "GORF"
Scott Rogers the "Proof Reader"

NAMCO'S TIP LINE!

ALL THE HINTS, TRICKS AND CHEATS!!
UNDER 18, PLEASE HAVE YOUR PARENTS
PERMISSION. TOUCHTONE PHONES ONLY.

1-900-737-2262

\$.95/MIN

\$1.15/MIN LIVE 9-5 M-F
PACIFIC TIME

For questions and information not listed on the
900 line, write to:

Namco Hometek Inc.
150 Charcot Avenue, Suite A
San Jose, CA 95131-1102

Namco Online: <http://www.namco.com>

Visit our Website to get information about our
new titles.

LIMITED WARRANTY

Namco Hometek Inc. warrants to the original purchaser that this Namco Hometek Inc. game pak shall be free from defects in material and workmanship for a period of ninety (90) days from the date of purchase. If a defect covered by this limited warranty occurs during this 90-day limited warranty period, Namco Hometek Inc. will repair or replace the defective game pak or component part, at its option, free of charge.

This limited warranty does not apply if the defects have been caused by negligence, accident, unreasonable use, modification, tampering, or any other cause not related to defective material or workmanship.

LIMITATIONS ON WARRANTY

Any applicable implied warranties of merchantability and fitness for a particular purpose, are hereby limited to ninety (90) days from the date of purchase and are subject to the conditions set forth herein. In no event shall Namco Hometek Inc. be liable for consequential or incidental damages resulting from the possession or use of this product.

The provisions of the limited warranty are valid in the United States only. Some states do not allow limitations on how long an implied warranty lasts, or exclusion of consequential or incidental damages, so the above limitation or exclusion may not apply to you. This limited warranty provides you with specific legal rights. You may have other rights which vary from state to state.

Galaxian™

Defender™

THE TOWER OF
DRUAGA™

MS. PAC-MAN™

PHOZZON™

POLE
POSITION™
II

Namco Hometek Inc. 150 Charcot Avenue, Suite A, San Jose, CA 95131-1102
Namco Museum Volume 3™ & © 1996 Namco Ltd. All rights reserved.
Manufactured pursuant to license with Namco Holding Corp.



Licensed by Sony Computer Entertainment America for use with the PlayStation game console. PlayStation and the PlayStation logos are trademarks of Sony Computer Entertainment Inc. The ratings icon is a trademark of the Interactive Digital Software Association. Manufactured and printed in the U.S.A. THIS SOFTWARE IS COMPATIBLE WITH PLAYSTATION GAME CONSOLES WITH THE NTSC U/C DESIGNATION. U.S. AND FOREIGN PATENTS PENDING.

namco